



IDENTIFICATIONS ON NPC TEAM APPAREL

**PRACTICAL GUIDELINES
MILANO CORTINA 2026
PARALYMPIC WINTER GAMES**

MARCH 2025

INTERNATIONAL PARALYMPIC COMMITTEE

CONTENTS

1	Introduction	3	19	SPORT-BY-SPORT	20
2	Definitions	4	19.1	FIS PARA ALPINE SKIING / FIS PARA SNOWBOARD	21
3	General principles	7	19.2	WORLD PARA ICE HOCKEY	29
4	Clothing	9	19.3	FIS PARA CROSS-COUNTRY SKIING / IBU PARA BIATHON	37
5	Footwear	10	19.4	WCF WHEELCHAIR CURLING	44
6	Accessories	11	19	GRAPHIC ILLUSTRATIONS	52
7	Guidance on placement	12	20	SUMMARY	56
8	Third party identifications	13	21	ACKNOWLEDGEMENTS	56
9	NPC Emblems and national identification	14			
10	Designs	15			
11	Homologation marks	15			
12	International Federation identifications	15			
13	Use of Milano Cortina 2026 emblem and wordmark	16			
14	Measuring authorised identifications	17			
15	Victory ceremonies and interviews	17			
16	Responsibility for compliance	18			
17	Consequences of infringement to the Guidelines	18			
18	Submission process and questions	19			

1 INTRODUCTION

The International Paralympic Committee (IPC) is pleased to present the Identifications on NPC Team Apparel - Practical Guidelines for the Milano Cortina 2026 Paralympic Winter Games. This document contains the general rules concerning the authorized manufacturer identifications and their applications to all apparel, meaning clothing (any piece of attire worn by a participant, including, without limitation, competition clothing as prescribed within the rules of each sport), footwear (shoes or boots worn by a participant) and clothing accessories (any article that is of an accessory nature, worn by a participant but which are not essential to the participation in the event).

The rules applicable to non-clothing accessories, sports equipment and other items can be found in this document. The Paralympic Winter Games place the national and Paralympic identity of athletes at the forefront which helps to further distinguish the Paralympic Games, whilst respecting the significant contribution that sporting goods manufacturers provide. Founded on the approach followed by the International Olympic Committee (IOC) for the Olympic Games, one of the key factors that differentiate the Paralympic Games from other sporting events is the visual presentation of the Games, which includes the 'look' of the participants, the venues and the field of play.

The purpose of these Guidelines is to clarify the use of apparel identifications using visual diagrams to illustrate the regulations of the IPC Handbook. These Guidelines apply to all persons participating in the Paralympic Games.

Furthermore, the Guidelines aim at providing clarifications on how the identification of the manufacturer may be used (or not) in general and specific situations. They are not intended to restrict or otherwise impair new and innovative technological design features of clothing, equipment and accessories as long as those are in conformity with the rules and regulations applicable for the Paralympic sports concerned and these Guidelines.

Notwithstanding the above, the identifications on NPC Team Apparel Guidelines shall be used subject to the understanding that (i) in case any term of these Guidelines is in contradiction with the IPC Handbook, the latter shall prevail and (ii) the IPC Governing Board shall be the sole authority to finally determine whether the use of a manufacturer name, designation, trademark, logo or any other distinctive sign complies with the IPC Handbook and these Guidelines. These Guidelines will be distributed to all National Paralympic Committees (NPCs) and International Federations (IFs). We encourage all parties to make use of this reference manual during the design and production of clothing, equipment, accessories and footwear items for the Milano Cortina 2026 Paralympic Winter Games.





2 DEFINITIONS

Authorised Identifications include:

Name	Description
Manufacturer identification	The normal display of the name, designation, trademark, or logo or any other distinctive sign of the apparel manufacturer. Manufacturer identifications do not include encrypted or encoded supports, such as barcodes or QR codes, or URLs, social media accounts or hashtags.
NPC Emblem	Either (i) the institutional or (ii) the commercial/team emblem of a participating NPC, as approved by the IPC.
Milano Cortina 2026 Emblem and Wordmark	The official emblem of the Milano Cortina 2026 Paralympic Winter Games, as approved by the IPC, and the words "Milano Cortina 2026", respectively.
Product Technology Identification	The technical identification (which shall not include any identification of the manufacturer, or any part thereof) used on clothing to identify any fabric technology.
IF Identification	The official emblem and/or the official name of an International Federation (IF)
Homologation Mark	Any identification deemed necessary for safety reasons, prescribed within IF rules and regulations and highlighted in the Sport-by-Sport section (e.g. "CE" or a similar non-commercial certification logo).

Identifications on
IPC Team Apparel
Practical Guidelines
Milano Cortina 2026

General Guidelines

- Definitions



2 DEFINITIONS

Accessories:

Any article that is of an accessory nature (e.g. bag, eyewear, arm bands, gloves, socks, etc.), worn or used by a participant. These articles are not essential to the participation in the event.

Clothing:

Any piece of attire worn by a participant within Paralympic Games venues and sites. Clothing may be divided into the following categories:

- **Casual wear:** Any additional articles of clothing worn by a participant within Paralympic Games venues and sites.
- **Competition clothing:** Articles of clothing worn by a participant during all training sessions and competitions. Competition clothing is subject to additional IF regulations, specific to the respective sport.
- **Formal uniforms:** All articles of clothing worn by a participant for all Paralympic Ceremonies (e.g. Team Welcome Ceremony, Opening, Closing and Victory Ceremonies).

Clothing Brand:

A brand principally used in the business of manufacturing, providing, distributing, and selling clothes and which is (i) not principally used for non-clothes products, (ii) not confusingly similar or identical to an identification used in another line of business, unrelated to clothes.

Footwear:

Any footwear (e.g. shoes, boots, etc.) worn by a participant.

Item:

Any piece of clothing, equipment, accessory or any other item used or worn by any person participating in the Paralympic Winter Games, appearing on the field of play or within other Paralympic Winter Games venues and sites.

Identifications on
IPC Team Apparel
Practical Guidelines
Milano Cortina 2026

General Guidelines

- Definitions

2 DEFINITIONS

Mobility equipment:

Any equipment used by a participant for mobility purposes (e.g. wheelchair, prosthetics).

Participant:

Any person participating in the Paralympic Games, in particular, but not limited to, athletes, officials, technicians (e.g. equipment technicians) and other accredited personnel within Paralympic Games venues, sites and press areas.

For the avoidance of doubt, when referring to a “person participating in the Paralympic Games”, these guidelines refer to any athlete, official and any other accredited person within Paralympic Games venues, sites and press areas.

Sports equipment:

Any sport-specific and necessary equipment used during sports competitions (e.g. skis, ski poles, snowboards etc.). These articles are essential to the participation in the event.

Technical gear:

Such installations, equipment and other apparatus not worn or used by participants (e.g. timing equipment and scoreboards).

Please note that any Olympic marks are not authorised identifications.



Identifications on
IPC Team Apparel
Practical Guidelines
Milano Cortina 2026

General Guidelines

- Definitions



3 GENERAL PRINCIPLES

Pursuant to the IPC Handbook, Section I, Sub-Section 3 (Paralympic Games Principles), no form of publicity or propaganda, commercial or otherwise, may appear on persons, sportswear, accessories or, more generally, on any article of clothing or equipment whatsoever worn or used by persons participating in the Paralympic Games, except for the identification of the manufacturer of the article or equipment concerned, provided that such identification shall not be marked conspicuously for advertising purposes.

An **authorised identification** may only be used in compliance with the terms of the IPC Handbook, these Guidelines or as further approved in writing by the IPC.

The IPC reserves the right to prohibit the use of any authorised identification on any given item in order to ensure the spirit of the principles of the IPC Handbook and these guidelines are respected.

Unless specifically mentioned otherwise hereinafter particularly in the “Sport-by-Sport section”) or unless otherwise indicated in writing by the IPC, the following general principles shall apply:

- No use of any manufacturer identification may be made in a conspicuous way. No apparel may be used for advertising purposes. In particular, apparel will be considered to be used for advertising purposes when the identification on such apparel is not related to sport or is only featured or used for the purpose of conspicuous exposure during the Paralympic Winter Games.



Identifications on
IPC Team Apparel
Practical Guidelines
Milano Cortina 2026

General Guidelines

- General Principles



3 GENERAL PRINCIPLES

- No identification other than an authorised identification may appear on any item.
- Only one manufacturer identification per piece of apparel shall be permitted except as provided in these Guidelines.

Exception: Where one-piece body suits are used in competition, one identification of the manufacturer shall be permitted above the waist and one below the waist, provided all other principles are respected.

- Where the manufacturer identification is not a clothing brand, such identification constitutes conspicuous advertising and so shall not be permitted on apparel for clothing items, the manufacturer identification may be that of some clothing brand.
- Participants must not contribute to or participate in any conspicuous advertising within the Games venues and sites, and, in particular, on the field of play.
- Personal mobility equipment refers to personal wheelchairs, prosthetics, etc., which are used outside of competition. For usage of mobility equipment inside competition, please refer to the respective sport-by-sport list. Personal mobility equipment is accepted in the Paralympic Games venues as commercially available.
- The IPC may further prohibit the use of any authorised identification on any apparel item in order to ensure the spirit of the principles of the IPC Handbook and these Guidelines are respected.



Identifications on
IPC Team Apparel
Practical Guidelines
Milano Cortina 2026

General Guidelines

- General Principles

4 CLOTHING

- The size of a manufacturer identification shall not exceed 30cm² for Clothing.
- One additional identification, strictly limited to product technology identifications, shall be permitted per clothing item and shall not exceed 10cm².
- Where one-piece body suits are used in competition, each of the manufacturer identification and the product technology identification shall be permitted once above and once below the waist, provided all other principles are respected.
- One manufacturer identification will be permitted on zippers and buttons, and should appear in the same colour as the concerned item (i.e. tone on tone), as long as such identifications are not otherwise conspicuous.
- In all instances where the Item contains elastic material (such as LYCRA®), the authorised identification size shall be measured stretched (e.g. as worn by the athlete).

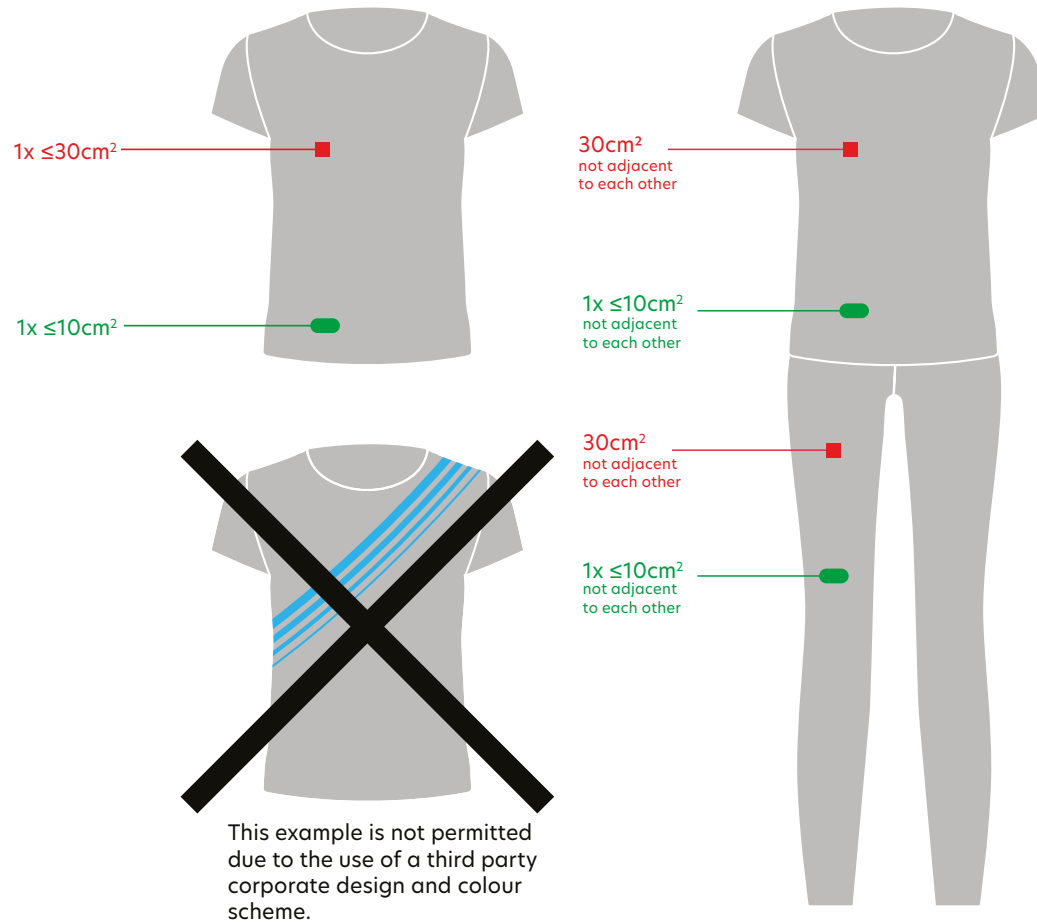

Identifications on
IPC Team Apparel
Practical Guidelines
Milano Cortina 2026

General Guidelines

- Clothing



5 FOOTWEAR

Footwear may carry the manufacturer identification as displayed on products sold on the retail consumer market at least six months before the Games, provided that such identifications are not otherwise conspicuous.

Athletes' names are usually not allowed on footwear unless required in the Sport-by-Sport section or already included on shoes sold in stores at least six months before the Games.

Personalized footwear isn't allowed since it doesn't match the standard designs sold in the retail market.



Identifications on
IPC Team Apparel
Practical Guidelines
Milano Cortina 2026

General Guidelines

- Footwear

6 ACCESSORIES

Clothing accessories may carry identifications as per the following, subject to any stricter IF rules which would prevail for each concerned sport, as indicated within the Sport-by-Sport section and in each case provided that such identifications are not otherwise conspicuous:

Armbands

One (1) manufacturer identification per item, with a maximum size of 6cm².

Bags

One (1) manufacturer identification per item, not greater than 10% of the surface area, to a maximum size of 60cm².

Socks

One (1) manufacturer identification per item, with a maximum size of 10cm² or two (2) marks of 5 cm² each.

Gloves

One (1) manufacturer identification per item, with a maximum size of 8cm².

Headgear

One (1) manufacturer identification per item, with a maximum size of 10cm² or two (2) manufacturer identifications per item to a maximum size of 5cm² each, placed above each ear.

Eyewear

May carry the manufacturer identification as displayed on products sold on the retail consumer market at least six (6) months before the Games, with the identifications permitted on the lenses provided that such identifications are engraved into the lens and are not deemed as conspicuous by IPC.

For any accessories not listed above, the size of the manufacturer identification shall not exceed 6cm².

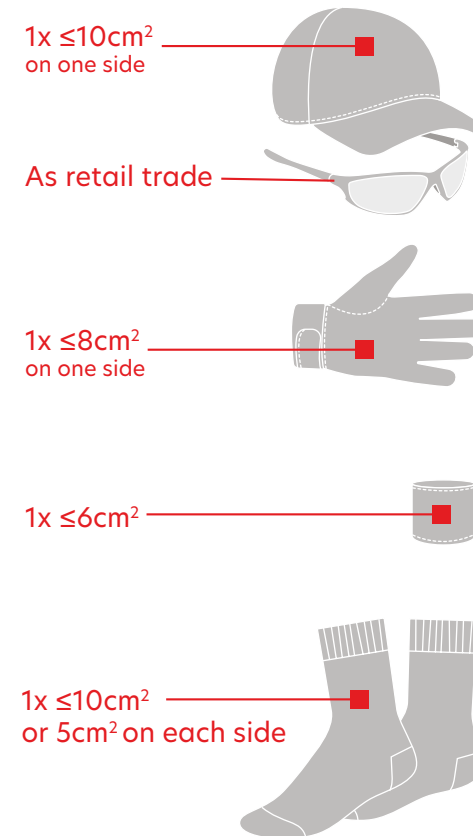

Identifications on
IPC Team Apparel
Practical Guidelines
Milano Cortina 2026

General Guidelines

- Accessories



7 GUIDANCE ON PLACEMENT

No manufacturer identification may appear in combination with any other authorised identification (product technology identifications, national identifications, homologation marks).

Manufacturer identifications may not appear close or adjacent to other Authorised Identifications, in order to avoid a composite logo effect or a repetitive effect. This applies also in case of several layers of Items worn by the same person or for one-piece body suits.

No authorised identification may appear on the neck or the collar, on the body (e.g., tattoo) of any person participating in the Games or on any of the following items including but not limited to headphones, water bottles, coolers, umbrellas, towels, bandages (e.g. kinesiology tape), contact lenses, earplugs, mouth guards and nose clips. This list is exemplary and non-exhaustive and may be amended and completed from time to time by the IPC.

Any change shall be communicated by the IPC to the NPCs and IFs.

On upper body clothing items, manufacturer identifications should as much as possible be placed on the chest or on the sleeve.



Identifications on
IPC Team Apparel
Practical Guidelines
Milano Cortina 2026

General Guidelines

- Guidance on Placement



8 THIRD PARTY IDENTIFICATIONS

No third-party reference or name may appear on any item of apparel, including:

- the names or nicknames of participants or any other persons (unless listed as a technical requirement in the Sport-by-Sport section),
- any designation, trademark, logo, corporate design and/or colour scheme (including, but not limited to, those of sponsors, National Federations, IFs, public or governmental authorities, and clubs);
- any other distinctive sign (whether direct or indirect, such as QR codes or barcodes) and
- URL, social media accounts, and hashtags

No item of apparel may feature any identification that relates to a product, service or in any other way does not comply with the principles of the IPC Handbook.

The use of certain authorised identifications (such as IF Identifications, the Milano Cortina 2026 emblem and wordmark) is limited and restricted to certain items only and may not be used otherwise as specifically indicated herein.



Identifications on
IPC Team Apparel
Practical Guidelines
Milano Cortina 2026

General Guidelines

- Third Party Identification



9 NPC EMBLEMS AND NATIONAL IDENTIFICATION

Subject to the General Principles (pages 7-8), NPCs are encouraged to use their national colours, name, flag, and emblems, as well as NPC emblems (hereinafter, national identifications), to visually enhance the national identity of their apparel.

NPCs have the right to choose the national identification(s) which will be used by their delegations on clothing (i.e. NPC institutional or team emblem or national flag).

No maximum frequency or sizes are applied to national identifications, unless limitations are imposed within a specific sport's technical regulations (please refer to the Sport-by-Sport section for more details).

NPCs, particularly the NPC of the country hosting the Paralympic Winter Games (in this case, the Italian Paralympic Committee), may not use the "Look of the Games" in any way which creates confusion between the Milano Cortina 2026 workforce and the athletes and officials of the host country delegation.

NPCs MUST NOT use:

- Any Olympic marks (e.g., Olympic rings, NOC emblem, "National Olympic Committee of country")
- International or National Sport Federation emblems
- IPC marks (e.g. Paralympic symbol) as a stand-alone element
- Any form of publicity or propaganda (commercial or otherwise)
- National anthems lyrics, motivational words, public/political messaging or slogans related to national identity

Identifications on
IPC Team Apparel
Practical Guidelines
Milano Cortina 2026

General Guidelines

- NPC Emblems and National Identification



10 DESIGNS

Designs of apparel must comply with the specifications of these Guidelines. A design may be used for one Paralympic and one Paralympic Winter Games but must be changed before the following Paralympic or Paralympic Winter Games, as the case may be.

Authorised identifications or any portion or variations thereof (such as graphic and/ or text that serve as concept extensions) cannot be used in designs (e.g., repetitions, extensions, distortions, watermarks, patterns, etc.) of items.

For the avoidance of doubt, drawings, colour schemes, combinations, patterns, prints, letters, numerals, geometric elements, slogans, taglines, words and/or designs that derive or refer or otherwise create the impression that they are identical or similar to a manufacturer identification (including, in particular, exclusive identifiers*), may not be used in designs of items for the Paralympic Games.

* Exclusive identifier(s) means any design or sign (or part or variation thereof) used by the manufacturer on clothing, equipment or accessories in the preceding edition of, respectively, the Paralympic Games and Paralympic Winter Games (i.e. exclusive identifier(s) can be used for one Paralympic and one Paralympic Winter Games, but must be changed before the following Paralympic or Paralympic Winter Games, as the case may be).

11 HOMOLOGATION MARKS

If any identification is necessary for safety reasons and is prescribed within IFs rules and regulations (e.g. "CE" or a similar non-commercial certification logo) and included within the Sport-by-Sport section, such identification will be permitted on the item, in a location that allows technical verification by officials.

12 INTERNATIONAL FEDERATION IDENTIFICATIONS

IF identifications are only authorised for use on uniforms worn by IF officials. This includes all categories of IF staff as well as technical officials. For clothing worn by IF officials, one IF identification per item shall be permitted, with a maximum size of 30cm².

Identifications on
IPC Team Apparel
Practical Guidelines
Milano Cortina 2026

General Guidelines

- Designs
- Homologation Marks
- International Federation Identifications



13 USING THE MILANO CORTINA 2026 EMBLEM AND WORDMARK

NPCs and IFs may enhance the Paralympic identity of their uniforms (Clothing only) by using the Milano Cortina 2026 Emblem or Wordmark on a limited basis, provided the following conditions are observed.

- In general, the Milano Cortina 2026 Emblem and the Milano Cortina 2026 Wordmark must:
 - be sourced directly from Milano Cortina 2026 and used in accordance with the Milano Cortina 2026 Marks Usage Guidelines;
 - not be used for any commercial purposes including, but not limited to, licensed and replica merchandise; and
 - only be used once per Item of Clothing, with a maximum size of 30 cm²
- In particular, it is forbidden to associate the Milano Cortina 2026 Wordmark with an identification of the manufacturer.
- When used in conjunction with the NPC Emblem or IF Identification, the Milano Cortina 2026 Wordmark should be positioned under the NPC Emblem or IF Identification with a distinctive gap or separation between the Milano Cortina 2026 Wordmark and the NPC Emblem or IF Identification or separated by a small dividing line.

The Milano Cortina 2026 Wordmark can only be reproduced in its entirety as defined in the Milano Cortina 2026 Marks Usage Guidelines or in a generic font (i.e. Arial, Helvetia, etc.).

- The Milano Cortina 2026 Emblem may be used on competition, IF technical delegates (field of play) and NPC Clothing and must absolutely appear alone. It is forbidden to associate the Milano Cortina 2026 Emblem with any other Authorised Identification (such as an identification of the manufacturer or an NPC Emblem or IF Identification).

The Milano Cortina 2026 Emblem can only be reproduced in its entirety as defined in the Milano Cortina 2026 Marks Usage Guidelines.



Milano Cortina Emblem



Milano Cortina Wordmark

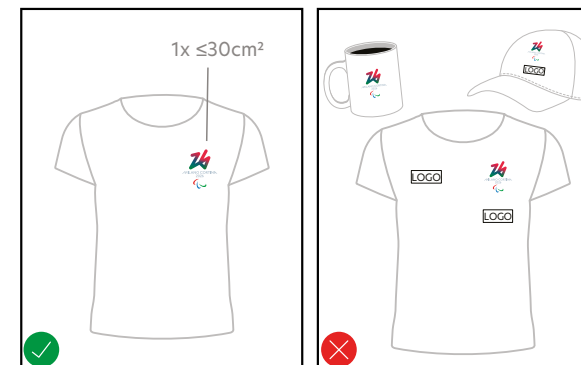

Identifications on
IPC Team Apparel
Practical Guidelines
Milano Cortina 2026

General Guidelines

- Using the Milano Cortina 2026 Emblem and Word Mark



14 MEASURING THE IDENTIFICATION OF THE MANUFACTURER

Regular shapes

Where the identification of the manufacturer appears as a rectangle or square, the mathematical rules used to calculate the surface area of the shape will be applied.

Area= a x b

Irregular shapes

Where the identification of the manufacturer is an irregular shape, a rectangle or square will be traced around the identification, and the mathematical rules used to calculate the surface area of the rectangle or square shall be applied.

Area= a x b

Combined shapes

Where the identification of the manufacturer combines the manufacturer name with the manufacturer logo, a rectangle or square will be traced around the combined identification and the surface area of the rectangle or square shall be calculated in its entirety.

Area= a x b

Area = a x b



Area = a x b

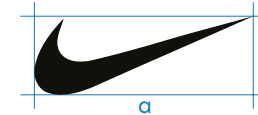

Area = a x b



Identifications on
IPC Team Apparel
Practical Guidelines
Milano Cortina 2026

General Guidelines

- Measuring the identification of the manufacturer
- Victory Ceremonies and Interviews

15 VICTORY CEREMONIES AND INTERVIEWS

No sports equipment or Accessories may be brought to the victory ceremony. This applies also to interviews, with the exception of the mixed zone when used as an exit from the competition area, or if the sports equipment is worn by the athlete (e.g. helmet, eyewear, etc.).

No personal accessories, including but not limited to mobile phones, plush toys, water bottles, national flags, banners (of any type) and point of view camera devices, are permitted on podiums.



16 RESPONSIBILITY FOR COMPLIANCE

It is the NPCs responsibility to comply with the rules and regulations of the IPC Handbook including but not limited to the Identifications on NPC Team Apparel - Practical Guidelines.

NPCs shall be primarily responsible for ensuring that all items worn or used by the members of their delegation comply with these guidelines.

Under the supervision of the IPC and with the support of OCOG personnel, the IFs shall implement a system of enforcing the compliance of items (e.g. sports equipment) in relation to their respective sport.

17 CONSEQUENCES OF INFRINGEMENT TO THE GUIDELINES

The IPC and OCOG will remain vigilant throughout the Paralympic Winter Games. At any time, those participants, which are not in compliance with the IPC rules and regulations, may be subject to sanction. According to the IPC Handbook, any violation of these rules could lead to disqualification and/or withdrawal of the accreditation of the person concerned as well as other possible sanctions, in accordance with the decision of the IPC Governing Board, or in accordance with the technical rules of the respective sport. Any identification of the manufacturer (including, any usage of exclusive identifiers) infringing upon these guidelines shall be removed or covered (as applicable) in accordance with the instructions given by representatives of the IPC, OCOG or the relevant IF to the participants.

Identifications on
IPC Team Apparel
Practical Guidelines
Milano Cortina 2026

General Guidelines

- Responsibility for Compliance
- Consequences of infringement to the Guidelines



18 SUBMISSION PROCESS AND QUESTIONS

The submission process will be co-ordinated via a specific module of the platform InMotion which is open for submissions now. To upload any visual examples for IPC pre-inspection, please visit <https://db.ipc-services.org/inMotion/app/login>, entering the access codes used by the NPC Primary User for InMotion.

If you want to apply for an additional account, please follow the steps on the website after pressing the “**Register new account**” link.

Specific information and assistance are available through the IPC Brand Department. For any further assistance the IPC welcomes and encourages all NPCs to consult with: brand@paralympic.org

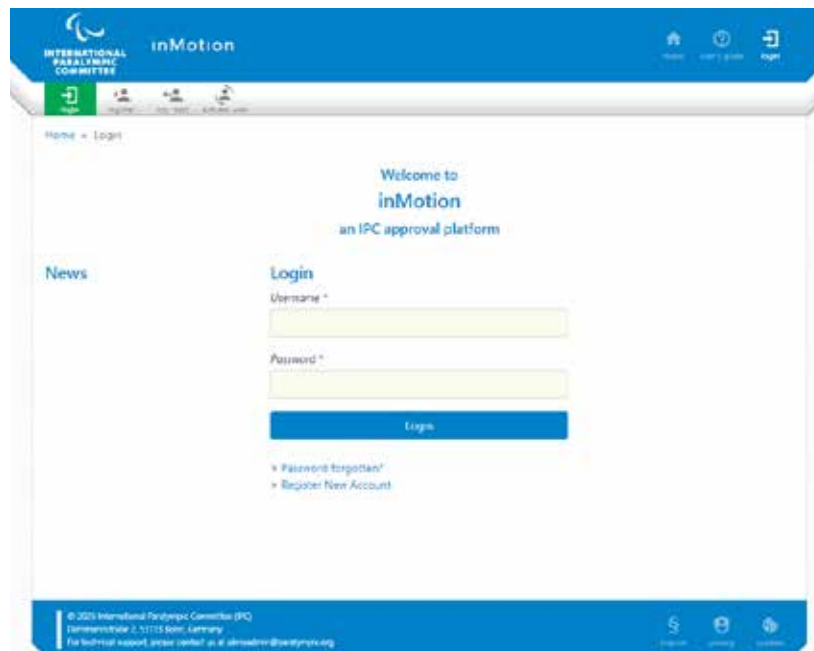

Please note:
The submission platform will be open until 31 January 2026

Identifications on
IPC Team Apparel
Practical Guidelines
Milano Cortina 2026

General Guidelines

- Submission process and questions

19 SPORT-BY-SPORT

Introduction

This section provides visual illustrations regarding the placement and size of the Identification of the manufacturer on sport specific items of clothing and accessories.

Each type of identification mark is represented by a shape and colour, as indicated in the coding below. It is also specified if the identification must be placed in the precise location indicated on the illustration [Precise] or if the placement is not specified in the guidelines [Floating].



Identifications on
IPC Team Apparel
Practical Guidelines
Milano Cortina 2026

General Guidelines

- Sporty-by-sport



Identifications on
IPC Team Apparel
Practical Guidelines
Milano Cortina 2026

Sport-by-Sport List

- FIS Para Alpine Skiing
- FIS Para Snowboard



**19.1 FIS PARA ALPINE SKIING /
FIS PARA SNOWBOARD**



Front

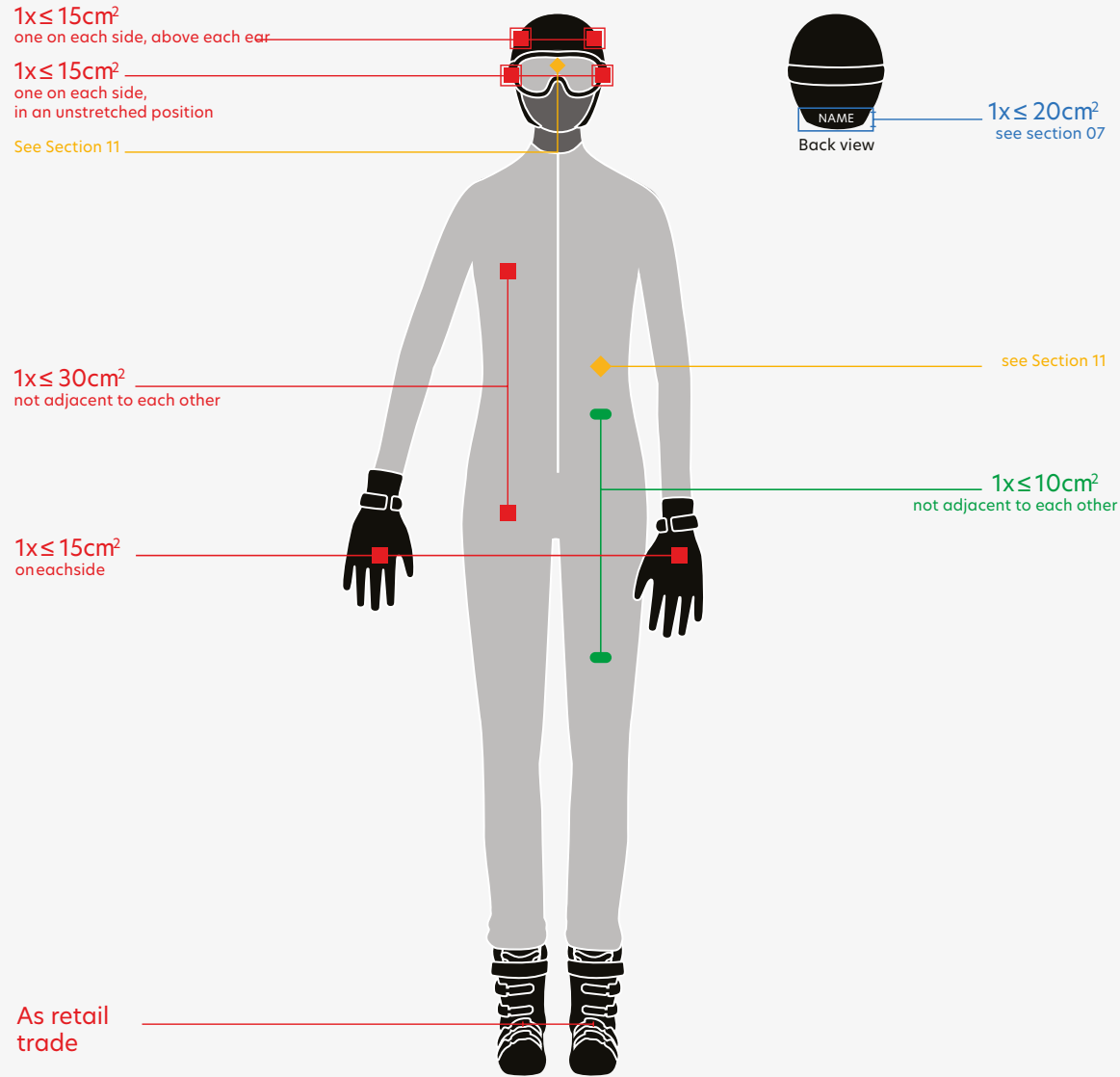

Identifications on IPC Team Apparel Practical Guidelines Milano Cortina 2026

Sport-by-Sport List

- FIS Para Alpine Skiing
- FIS Para Snowboard

Floating Precise

- Manufacturer Identification
- Product Technology Identification
- NPC Emblem and National Identity
- Homologation Marks

Each type of identification mark is represented by a shape and colour, as indicated in the coding below. It is also specified if the identification must be placed in the precise location indicated on the illustration [Precise] or if the placement is not specified in the guidelines [Floating].



Equipment

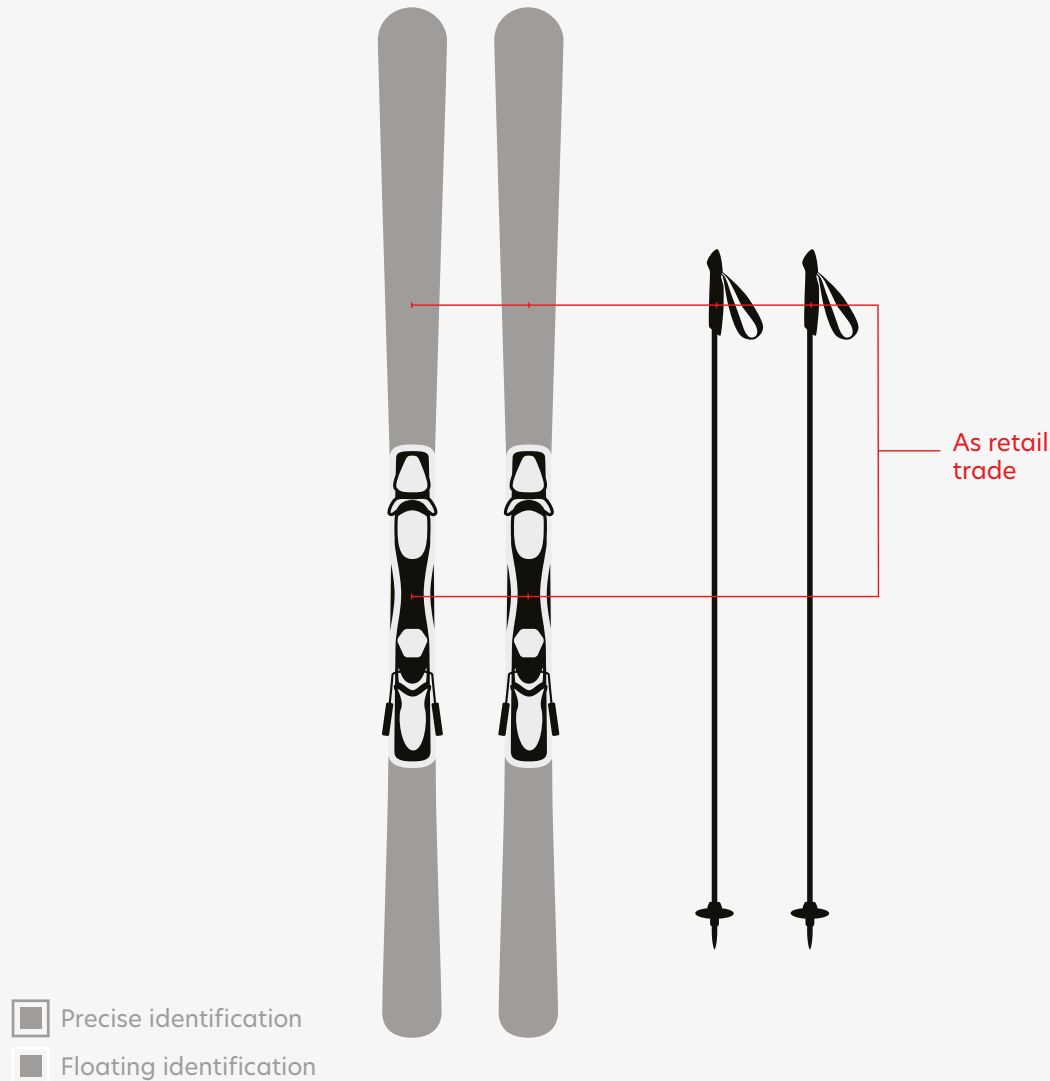

Identifications on
IPC Team Apparel
Practical Guidelines
Milano Cortina 2026

Sport-by-Sport List

- FIS Para Alpine Skiing
- FIS Para Snowboard

Each type of identification mark is represented by a shape and colour, as indicated in the coding below. It is also specified if the identification must be placed in the precise location indicated on the illustration [Precise] or if the placement is not specified in the guidelines [Floating].



Clothing

Competition clothing/	One identification of the manufacturer per clothing item will be permitted, to a maximum size of 30cm ² .
Warm-up & Training suits	<p>One identification of the manufacturer will be permitted on zippers and buttons and should appear in the same colour as the concerned item (i.e. tone on tone), as long as such identifications are deemed not conspicuous by the IPC.</p> <p>One additional product technology identification will be permitted per clothing item, to a maximum size of 10cm².</p>
One-piece bodysuit	<p>One identification of the manufacturer shall be permitted above the waist and below the waist, in accordance with the maximum sizes noted above; however, these identifications shall not be placed immediately adjacent to each other.</p> <p>One product technology identification shall be permitted above the waist and below the waist, in accordance with the maximum sizes noted above; however, these identifications shall not be placed immediately adjacent to each other.</p>
Collars/ Roll necks	If a roll neck or polo shirt is worn, no identification of the manufacturer may appear on the collar or on the neck. Only one identification of the manufacturer will be allowed; it may be situated on the chest, with a maximum size of 30cm ² .
Socks	Two identification of the manufacturer per accessory item will be permitted, to a maximum size of 10cm ² .
Gloves	One identification of the manufacturer per accessory item will be permitted, with a maximum size of 8cm ² per glove.

Identifications on
IPC Team Apparel
Practical Guidelines
Milano Cortina 2026

Sport-by-Sport List

- FIS Para Alpine Skiing
- FIS Para Snowboard

All General Principles apply unless expressly mentioned otherwise above (in particular in relation to size, frequency or location).



Headgear	One identification of the manufacturer per item, with a maximum size of 10cm ² or two identifications of the Manufacturer per accessory item will be permitted, with a maximum size of 5cm ² each and placed above each ear.
----------	--

Eyewear	May carry the identification of the manufacturer as displayed on products sold through the retail consumer market at least six (6) months before the Paralympic Winter Games, with the identifications permitted on the lenses so long as such identifications are tone-one-tone, engraved into the lens and are not deemed as conspicuous by the IPC.
---------	--

Sport Equipment

Skis/Snowboards Bindings/ Poles/ Ski straps/ Outtriggers	May carry the identification of the manufacturer as displayed on products sold through the retail consumer market at least six (6) months before the Paralympic Winter Games and as long as it is deemed a Sports Brand.
--	--

Helmet	<p>May carry two identifications of the manufacturer with a maximum size of 15cm², one on each side, placed over the ears.</p> <p>Same colour identifications that are moulded on the helmet and product technology identification related to the helmet protection attributes are accepted as long as they are generally used on products sold through the retail consumer market at least six (6) months before the Paralympic Winter Games.</p> <p>All helmets should be approved by FIS and display FIS approval mark.</p>
--------	---

Identifications on
IPC Team Apparel
Practical Guidelines
Milano Cortina 2026

Sport-by-Sport List

- FIS Para Alpine Skiing
- FIS Para Snowboard

All General Principles apply unless expressly mentioned otherwise above (in particular in relation to size, frequency or location).



Arm/leg protection	<p>One identification of the manufacturer per arm and leg protection is permitted, to a maximum size of 12cm².</p> <p>An identification of the manufacturer on the hand protector of ski poles is permitted. The identification of the manufacturer may be divided into two parts per individual hand protector. The total surface area of the commercial markings per hand protector is limited to 15cm².</p>
Goggles	<p>May carry two identifications of the Manufacturer, no larger than 15cm² each in an unstretched position. A moulded identification of the manufacturer may appear on the frame in any position.</p> <p>This logo must be the same colour as the frame. A laser engraved or metallic/ black identification on the lens is accepted as long as long as the manufacturer identification is as displayed on products sold through the retail consumer market at least six (6) months before the Paralympic Winter Games. Straps shall not measure more than 5cm in width. In case of double straps only one strap may carry the identification of the manufacturer.</p> <p>A product technology identification relating to the goggle lenses is accepted as long as the manufacturer identification is as displayed on products sold through the retail consumer market at least six (6) months before the Paralympic Winter Games. Straps (without goggles) with the identification of manufacturer of goggle suppliers may not be worn.</p>
Race gloves	<p>One identification of the manufacturer per accessory item will be permitted. The identification of the manufacturer may be divided into two parts per individual glove, with a maximum size of 15cm² per glove.</p>

Identifications on
IPC Team Apparel
Practical Guidelines
Milano Cortina 2026

Sport-by-Sport List

- FIS Para Alpine Skiing
- FIS Para Snowboard

All General Principles apply unless expressly mentioned otherwise above (in particular in relation to size, frequency or location).



Mobility Equipment/ Adaptive Equipment

Sit-ski/ Wheelchair/ Prosthetics	One identification of the manufacturer per equipment item will be permitted, not larger than 10 per cent of the surface area of the item, to a maximum size of 60cm ² . All mobility and adaptive equipment must also be submitted to the FIS for approval.
--	---

Accessories

Bag/Backpack Drinking belt	One identification of the manufacturer per bag will be permitted, covering no more than 10% of the surface, to a maximum size of 60cm ² .
Ski straps/ Waist bag/ Bottle belts	One identification of the manufacturer per accessory item will be permitted, to a maximum size of 10cm ² .
Scarves/ Neck warmers	No identification of the manufacturer will be permitted.
Shoes/ Boots	All footwear items may carry the manufacturer identification as displayed on products sold through the retail consumer market at least six (6) months before the Paralympic Winter Games.

Identifications on
IPC Team Apparel
Practical Guidelines
Milano Cortina 2026

Sport-by-Sport List

- FIS Para Alpine Skiing
- FIS Para Snowboard

All General Principles apply unless expressly mentioned otherwise above (in particular in relation to size, frequency or location).



IF specific technical requirements

The following IF technical requirements apply in relation to the General Guidelines:

Section 8. Third party Identifications (athlete names)

Helmets and headgear worn in competition may carry the name of an athlete. The athlete's name with a maximum size of 20 cm² must be placed at the back of the helmet or on the rear of a hat/headband for cross-country namely when a helmet is not worn. The athlete's name can only consist of the full name of the athlete in a standard font and size defined by FIS Para Alpine Skiing / FIS Para Snowboard which is the same for all athletes.

Section 9. Maximising national and Paralympic Identity

No IF specific regulations with regards to National Identifications, section 9 of the General Guidelines applies.

Section 11. Homologation marks (Required homologation marks)

A homologation mark/sticker must appear on the Alpine Skis (marking of radius on skis), on suits (printed marking).

Section 18. Submission Process (Mandatory IF verification process)

Pre Competition

All ski goggles (AS1) and adaptive equipment must be submitted to the Technical Official for review that should be aligning with the FIS Para Alpine Skiing and FIS Para Snowboard Equipment Rules.

Post Competition

An immediate post-competition control of skis/binding, boots and suits for Alpine skiing and Snowboard is compulsory.

All General Principles apply unless expressly mentioned otherwise above (in particular in relation to size, frequency, location or Sports Brand requirements).

Identifications on
IPC Team Apparel
Practical Guidelines
Milano Cortina 2026

Sport-by-Sport List

- FIS Para Alpine Skiing
- FIS Para Snowboard

All General Principles apply unless expressly mentioned otherwise above (in particular in relation to size, frequency or location).



Identifications on
IPC Team Apparel
Practical Guidelines
Milano Cortina 2026

Sport-by-Sport List

- World Para Ice Hockey

19.2 WORLD PARA ICE HOCKEY



Front

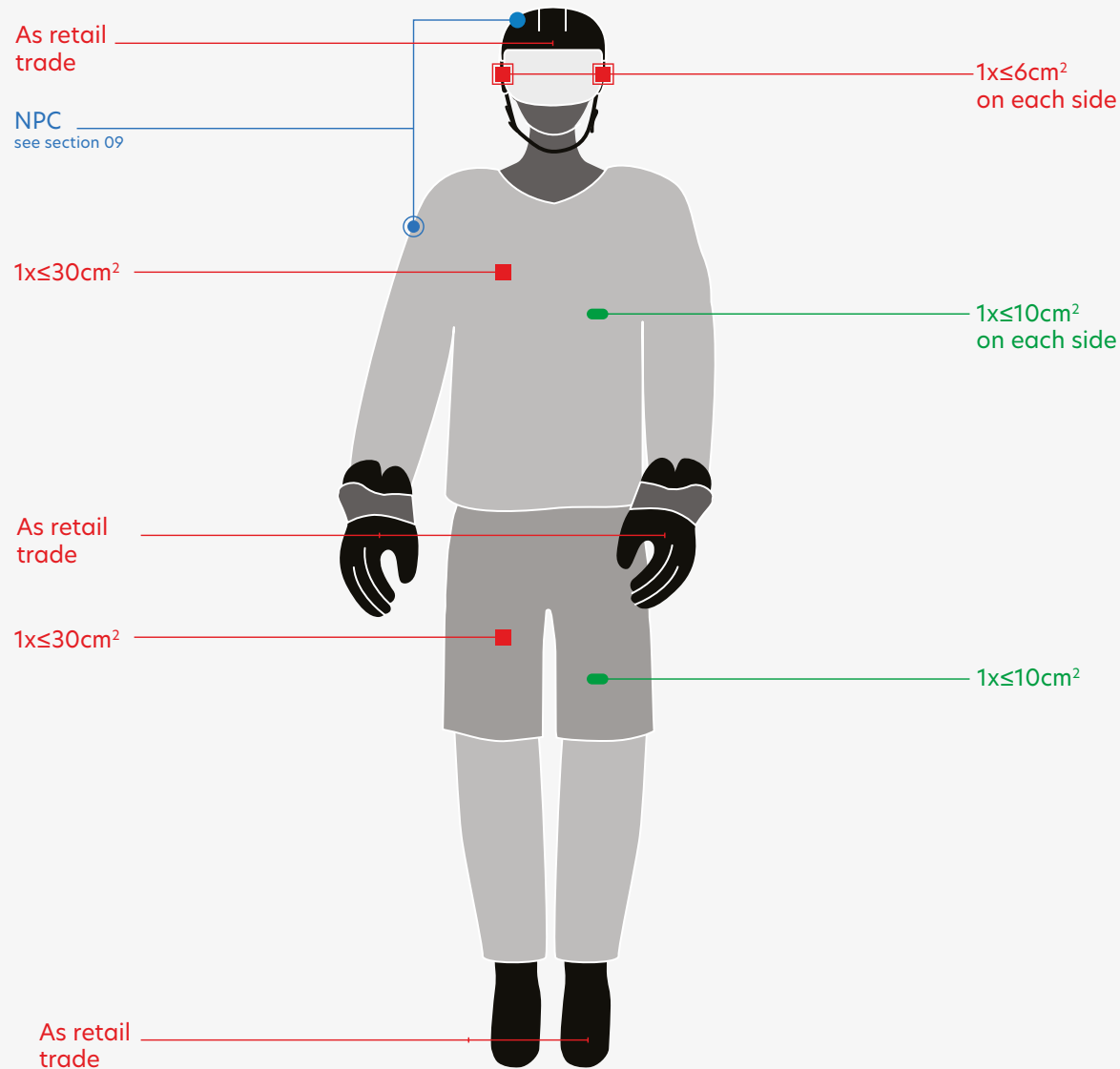

Identifications on
IPC Team Apparel
Practical Guidelines
Milano Cortina 2026

Sport-by-Sport List

- World Para Ice Hockey



Each type of identification mark is represented by a shape and colour, as indicated in the coding below. It is also specified if the identification must be placed in the precise location indicated on the illustration [Precise] or if the placement is not specified in the guidelines [Floating].



Back

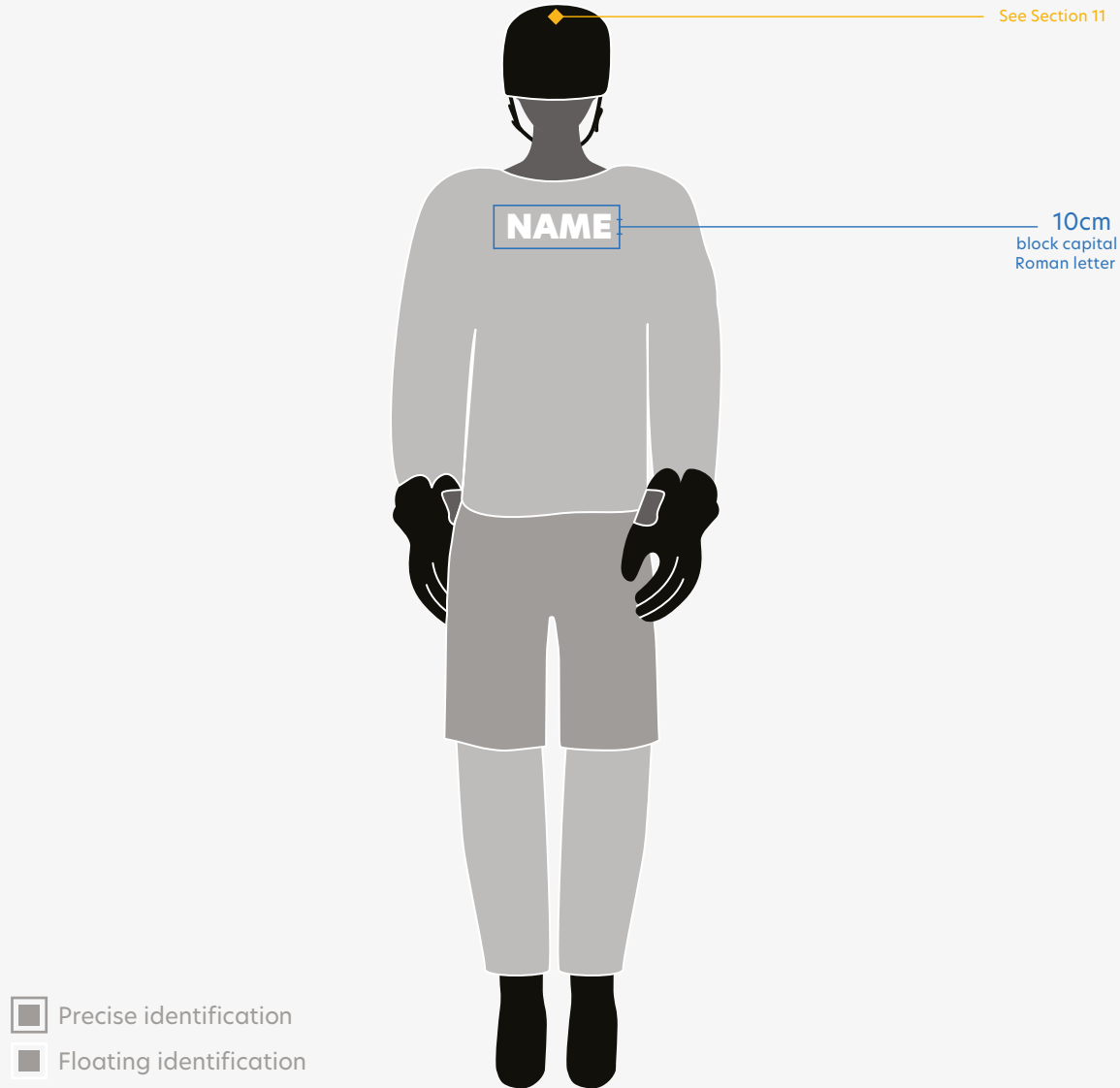

Identifications on IPC Team Apparel Practical Guidelines Milano Cortina 2026

Sport-by-Sport List

- World Para Ice Hockey



Each type of identification mark is represented by a shape and colour, as indicated in the coding below. It is also specified if the identification must be placed in the precise location indicated on the illustration [Precise] or if the placement is not specified in the guidelines [Floating].



Goalkeeper Front

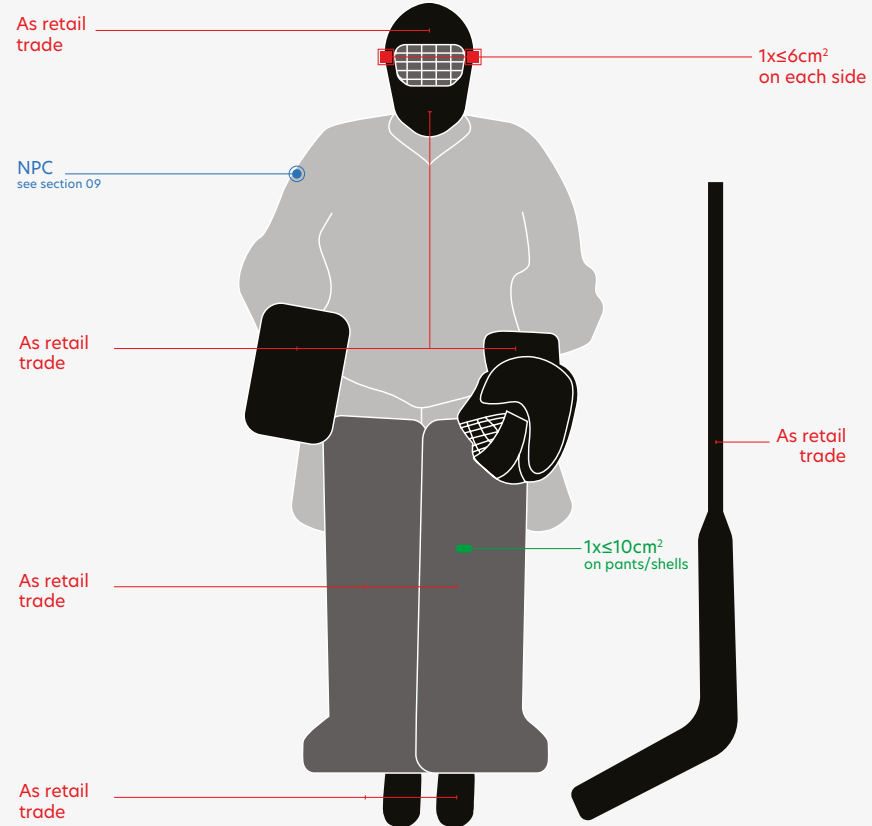

Back

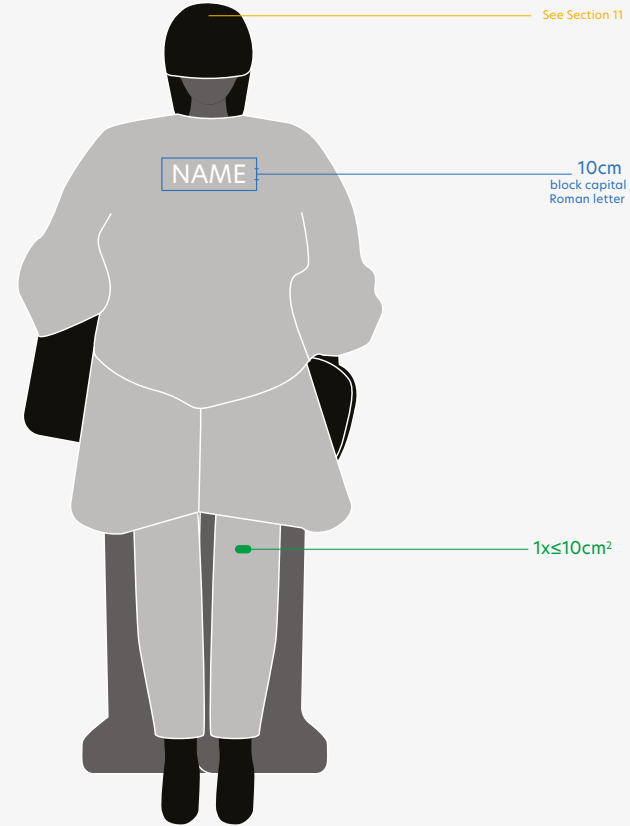

Identifications on IPC Team Apparel Practical Guidelines Milano Cortina 2026

Sport-by-Sport List

- World Para Ice Hockey

Floating	Precise	
		Manufacturer Identification
		Product Technology Identification
		NPC Emblem and National Identity
		Homologation Marks

Each type of identification mark is represented by a shape and colour, as indicated in the coding below. It is also specified if the identification must be placed in the precise location indicated on the illustration [Precise] or if the placement is not specified in the guidelines [Floating].



Clothing

Jersey/ Warm-up Jersey	<p>One identification of the manufacturer per clothing item will be permitted, to a maximum size of 30cm².</p> <p>One additional product technology identification will be permitted per clothing item, to a maximum size of 10cm².</p>
Pants/ Pant shells	<p>One identification of the manufacturer per clothing item will be permitted, to a maximum size of 30cm².</p> <p>One additional product technology identification will be permitted per clothing item, to a maximum size of 10cm².</p>
Compression shirts/ Roll necks	<p>If a compression shirt or roll neck is worn, no identification of the manufacturer may appear on the collar or on the neck.</p> <p>Only one identification of the manufacturer will be allowed; it may be situated on the chest, with a maximum size of 30cm².</p>
Hockey socks/ Socks tape	<p>No identification of the manufacturer may appear on these items.</p>

Sport Equipment

Helmet/ Head protector (full face mask) (Player and goalkeeper)	<p>May carry the identification of the manufacturer as displayed on products sold through the retail consumer market at least six (6) months before the Paralympic Winter Games and so long as it is deemed a Sports Brand.</p>
Facial protection (Player and goalkeeper)	<p>One identification of the manufacturer per item will be permitted on each side, with a maximum size of 6cm² on player facial protection.</p>

Identifications on
IPC Team Apparel
Practical Guidelines
Milano Cortina 2026

Sport-by-Sport List

- World Para Ice Hockey

All General Principles apply unless expressly mentioned otherwise above (in particular in relation to size, frequency or location).



Neck protection (Player and goalkeeper)	May carry the identification of the manufacturer as displayed on products sold through the retail consumer market at least six (6) months before the Paralympic Winter Games and so long as it is deemed a Sports Brand.
Gloves	May carry the identification of the manufacturer as displayed on products sold through the retail consumer market at least six (6) months before the Paralympic Winter Games and so long as it is deemed a Sports Brand.
Hockey sticks	May carry the identification of the manufacturer as displayed on products sold through the retail consumer market at least six (6) months before the Paralympic Winter Games and so long as it is deemed a Sports Brand.

Accessories

Bags (Player and goalkeeper)	May carry the identification of the manufacturer as displayed on products sold through the retail consumer market at least six (6) months before the Paralympic Winter Games and so long as it is deemed a Sports Brand.
Towels	No identification of the manufacturer may appear on these items.
Bottles	No identification of the manufacturer may appear on these items.

Shoes/footwear

Skates/ Skates Boots/ Foot Protection	All footwear items may carry the identification of the manufacturer as displayed on products sold through the retail consumer market at least six (6) months before the Paralympic Winter Games and so long as it is deemed a Sports Brand.
---	---

Mobility Equipment

Sledge/ Wheelchair/ Prosthetics	One identification of the manufacturer per equipment item will be permitted, not larger than 10 per cent of the surface area of the item, to a maximum size of 60cm ² .
---------------------------------------	--

Identifications on
IPC Team Apparel
Practical Guidelines
Milano Cortina 2026

Sport-by-Sport List

- World Para Ice Hockey

All General Principles apply unless expressly mentioned otherwise above (in particular in relation to size, frequency or location).



IF specific technical requirements

The following IF technical requirements apply in relation to the General Guidelines:

Section 8. Third party Identifications (athlete names)

Each player shall wear his/her name on the upper portion of the back of his/her jersey printed in up to 10cm high, block capital Roman letters. Each player shall wear an individual number 25 to 30cm in height, centred on the back of the jersey and 10cm in height on both shoulders. Numbers are limited to 1 to 99.

The captain must wear the letter "C", and alternate captains must wear the letter "A", 8 cm in height and in a contrasting color in front of the jersey, opposite to the position of the manufacturer identification mark.

Graffiti-type designs, patterns, artwork, drawings or slogans are not permitted on any part of the uniform.

Identifications on
IPC Team Apparel
Practical Guidelines
Milano Cortina 2026

Sport-by-Sport List

- World Para Ice Hockey

All General Principles apply unless expressly mentioned otherwise above (in particular in relation to size, frequency or location).



Section 9. Maximising national and Paralympic Identity

One flag/NPC emblem and one country/territory name or NPC code is permitted on the helmet. Furthermore, in accordance with the WPIH rules regarding national emblem placement, the NPC emblem may also be placed in the front of the players jersey.

Stickers showcasing the Milano Cortina 2026 Paralympic Winter Games may be placed on the players' helmet, if provided by the OCOG.

Section 11. Homologation marks

WPIH Homologation labels may appear on helmets and other items where safety tests have been carried out.

Section 18. Submission process

All goalie mask and helmet designs are to be submitted to the IPC and to World Para Ice Hockey for review prior to the Paralympic Winter Games.

All General Principles apply unless expressly mentioned otherwise above (in particular in relation to size, frequency, location or Sports Brand requirements).

Identifications on
IPC Team Apparel
Practical Guidelines
Milano Cortina 2026

Sport-by-Sport List

- World Para Ice Hockey

All General Principles apply unless expressly mentioned otherwise above (in particular in relation to size, frequency or location).



Identifications on
IPC Team Apparel
Practical Guidelines
Milano Cortina 2026

Sport-by-Sport List

- FIS Para Cross-Country Skiing
- IBU Para Biathlon

19.3 FIS PARA CROSS-COUNTRY SKIING / IBU PARA BIATHLON



Front

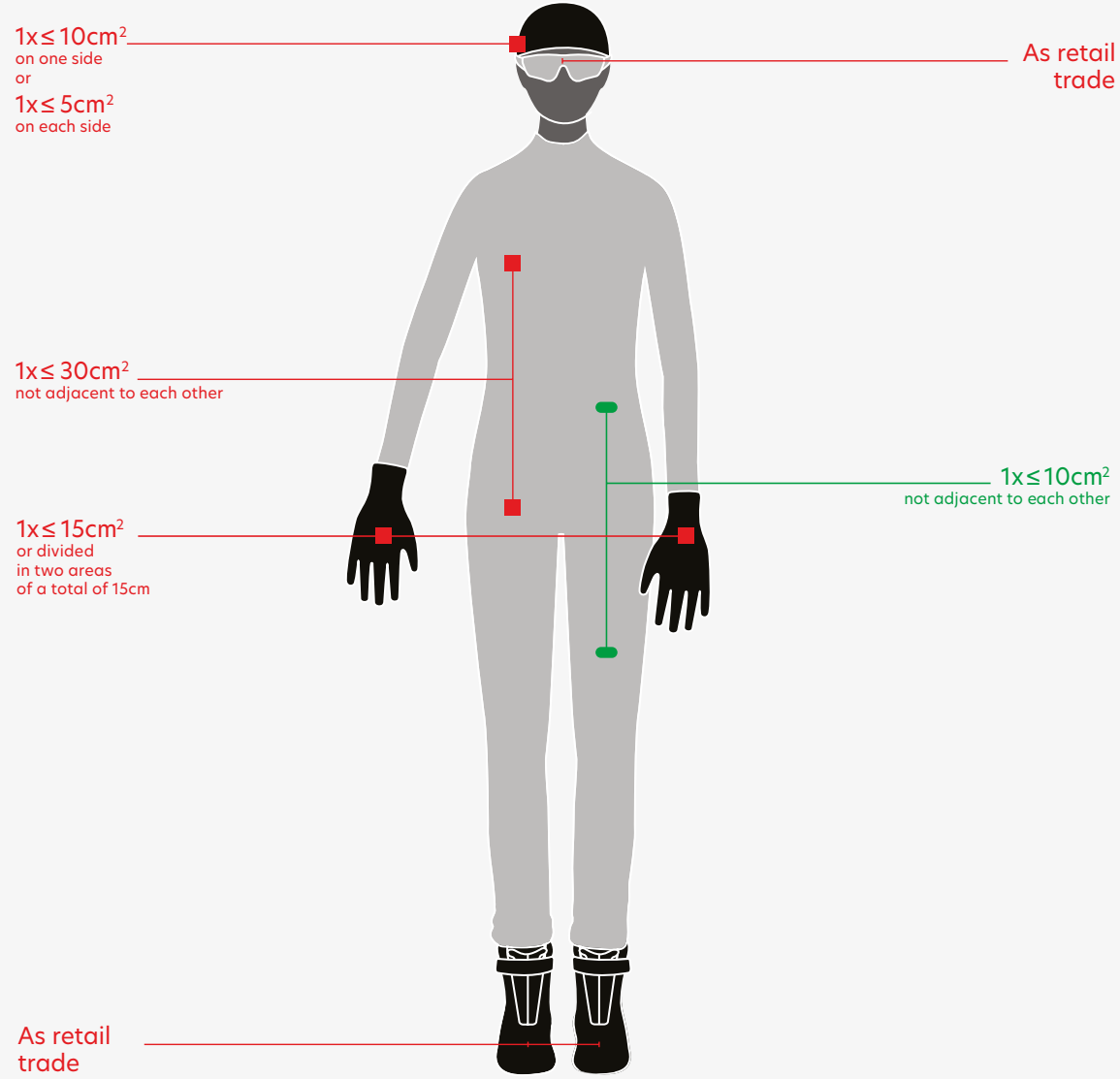

Identifications on
IPC Team Apparel
Practical Guidelines
Milano Cortina 2026

Sport-by-Sport List

- FIS Para Cross-Country Skiing
- IBU Para Biathlon



Each type of identification mark is represented by a shape and colour, as indicated in the coding below. It is also specified if the identification must be placed in the precise location indicated on the illustration [Precise] or if the placement is not specified in the guidelines [Floating].



Equipment

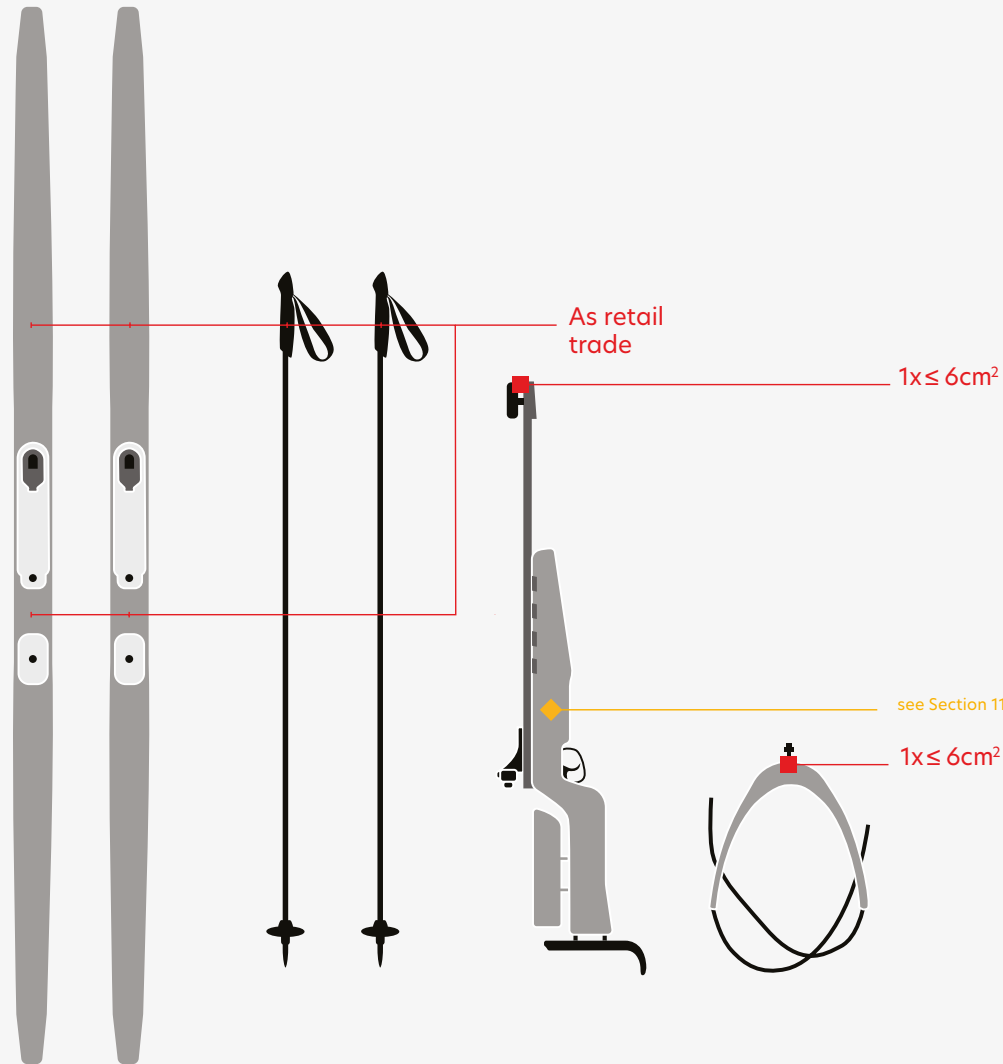

Identifications on
IPC Team Apparel
Practical Guidelines
Milano Cortina 2026

Sport-by-Sport List

- FIS Para Cross-Country Skiing
- IBU Para Biathlon

Floating	Precise	
		Manufacturer Identification
		Product Technology Identification
		NPC Emblem and National Identity
		Homologation Marks

Each type of identification mark is represented by a shape and colour, as indicated in the coding below. It is also specified if the identification must be placed in the precise location indicated on the illustration [Precise] or if the placement is not specified in the guidelines [Floating].



Clothing

Competition clothing/ Warm-up & Training suits	<p>One identification of the manufacturer per clothing item will be permitted, to a maximum size of 30cm².</p> <p>One additional product technology identification will be permitted per clothing item, to a maximum size of 10cm².</p>
Competition suit	<p>One-piece body suit One identification of the manufacturer and one product technology identification shall be permitted above the waist and below the waist, in accordance with the maximum sizes noted above; however, these identifications shall not be placed immediately adjacent to each other.</p> <p>Two-piece body suit One identification of the manufacturer per clothing item will be permitted, to a maximum size of 30cm².</p>
Collars/ Roll necks	<p>If a roll neck or polo shirt is worn, no identification of the manufacturer may appear on the collar or on the neck. Only one identification of the manufacturer will be allowed; it may be situated on the chest, with a maximum size of 30cm².</p>
Socks	<p>One identification of the manufacturer per accessory item will be permitted, to a maximum size of 10cm².</p>
Gloves	<p>One identification of the manufacturer per accessory item will be permitted, with a maximum size of 8cm² per glove.</p>
Headgear/ Headband	<p>One identification of the manufacturer per Item, with a maximum size of 10cm² or two identifications of the manufacturer per accessory item will be permitted, with a maximum size of 5cm² each and placed above each ear.</p>
Eyewear	<p>May carry the identification of the manufacturer as displayed on products sold through the retail consumer market at least six (6) months before the Paralympic Winter Games.</p>

Identifications on
IPC Team Apparel
Practical Guidelines
Milano Cortina 2026

Sport-by-Sport List

- FIS Para Cross-Country Skiing
- IBU Para Biathlon

All General Principles apply unless expressly mentioned otherwise above (in particular in relation to size, frequency or location).



Sport Equipment

Skis/ Bindings/ Poles	May carry the identification of the manufacturer as generally used on products sold through the retail trade during the period of six (6) months or more prior to the Games.
Rifle (including rifle stock)	One identification of the manufacturer per item will be permitted, to a maximum size of 6cm ² at the front end of the rifle barrel.
Rifle Shooting sling	One identification of the manufacturer per item will be permitted, to a maximum size of 6cm ² .
Rifle case/ Rifle bag	One identification of the manufacturer per item will be permitted, covering no more than a maximum total dimensions of 50cm to 15cm.
Arm loop	One identification of the manufacturer per accessory item will be permitted, to a maximum size of 30cm ² .
Telescope	Two identification of the manufacturer per item will be permitted per side, to a maximum area of 50cm ² .
Telescope stand	May carry the identification of the manufacturer with a maximum size of 15cm ² per leg.
Telescope carrying strap	One identification of the manufacturer will be permitted on carrying straps, to a maximum size of 30cm ² .
Warm up and race gloves	One identification of the manufacturer per item will be permitted, to a maximum size of 15cm ² or divided in two areas of a total of 15cm ² .

Identifications on
IPC Team Apparel
Practical Guidelines
Milano Cortina 2026

Sport-by-Sport List

- FIS Para Cross-Country Skiing
- IBU Para Biathlon

All General Principles apply unless expressly mentioned otherwise above (in particular in relation to size, frequency or location).



Mobility equipment / Adaptive Equipment

Sit-Ski/ Wheelchair/ Prosthetics	One identification of the manufacturer per equipment item will be permitted, not larger than 10 per cent of the surface area of the item, to a maximum size of 60cm ² .
--	--

Accessories

Bag/ Backpack/ Drinking belt	One identification of the manufacturer per item will be permitted, covering no more than 10 per cent of the surface, to a maximum size of 60cm ² .
Neck warmer	One identification of the manufacturer per accessory item will be permitted, with a maximum size of 15cm ² .

Shoes/Footwear

Shoes	All footwear items may carry the identification of the manufacturer as displayed on products sold through the retail consumer market at least six (6) months before the Paralympic Winter Games.
-------	--

Identifications on
IPC Team Apparel
Practical Guidelines
Milano Cortina 2026

Sport-by-Sport List

- FIS Para Cross-Country Skiing
- IBU Para Biathlon

All General Principles apply unless expressly mentioned otherwise above (in particular in relation to size, frequency or location).



IF specific technical requirements

The following IF technical requirements apply in relation to the General Guidelines:

Section 8. Third party Identifications (athlete names)

No names of athletes allowed on items, section 7 of the General Guidelines applies.

Section 9. Maximising national and Paralympic Identity

No IF specific regulations with regards to national identifications, section 9 of the General Guidelines applies.

Section 11. Homologation marks

A double-sided rifle control sticker may be placed on rifle stocks, each in the size of 12 x 4 cm. It is to be placed on the 15 x 4 cm large, even surface in such a way that it is not covered or cut off in any place. A free space of 1 cm is to be left on all sides of the sticker, in which no other logo may be placed, nor any other symbol or sticker.

Section 18. Submission process

Pre-Competition

All ski goggles (NS1) and adaptive equipment must be submitted to the Technical Official for review that should be aligning with the FIS Para Cross-Country Skiing Equipment Rules.

All General Principles apply unless expressly mentioned otherwise above (in particular in relation to size, frequency, location or Sports Brand requirements).

Identifications on
IPC Team Apparel
Practical Guidelines
Milano Cortina 2026

Sport-by-Sport List

- FIS Para Cross-Country Skiing
- IBU Para Biathlon

All General Principles apply unless expressly mentioned otherwise above (in particular in relation to size, frequency or location).



19.4 WCF - WHEELCHAIR CURLING

Identifications on
IPC Team Apparel
Practical Guidelines
Milano Cortina 2026

Sport-by-Sport List

- WCF Wheelchair Curling



Front

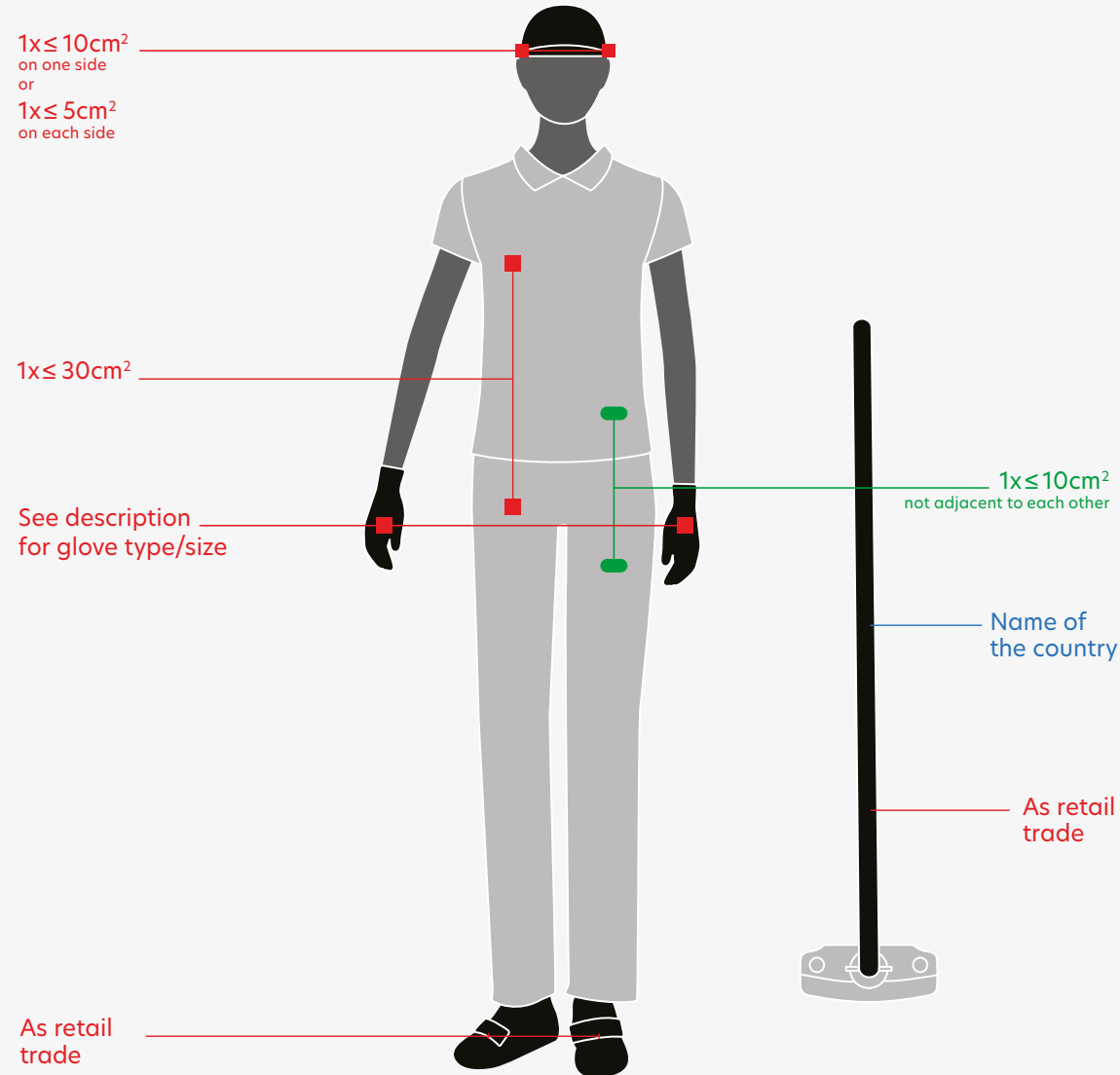

Identifications on
 IPC Team Apparel
 Practical Guidelines
 Milano Cortina 2026

Sport-by-Sport List

- WCF Wheelchair Curling





Each type of identification mark is represented by a shape and colour, as indicated in the coding below. It is also specified if the identification must be placed in the precise location indicated on the illustration [Precise] or if the placement is not specified in the guidelines [Floating].

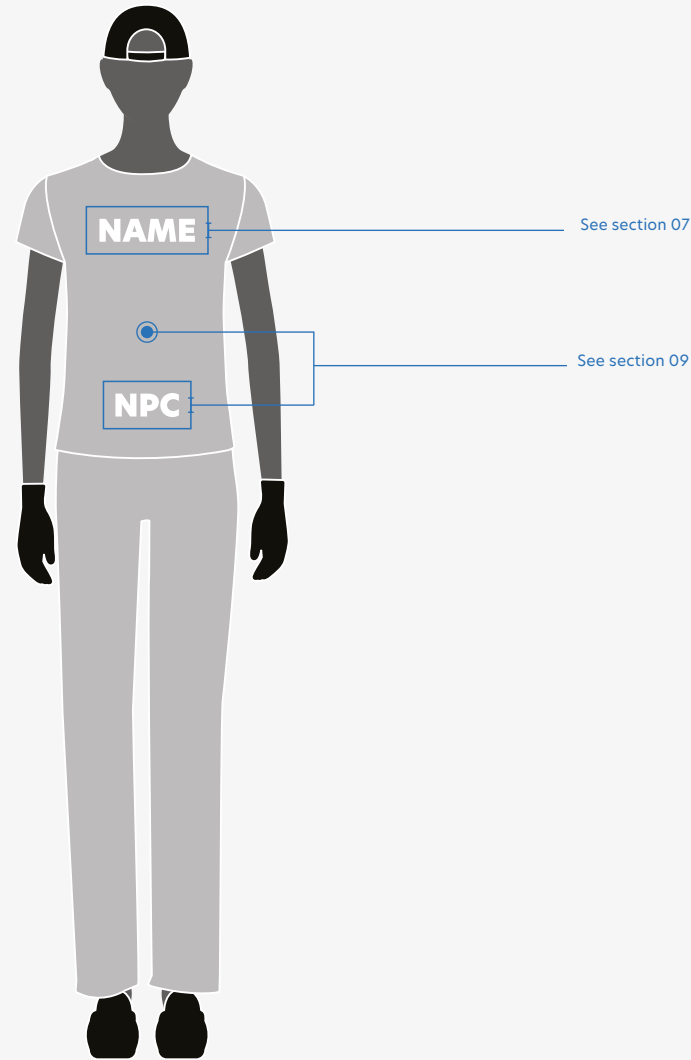

Back



-  Precise identification
-  Floating identification

Identifications on
IPC Team Apparel
Practical Guidelines
Milano Cortina 2026

Sport-by-Sport List

- WCF Wheelchair Curling



Each type of identification mark is represented by a shape and colour, as indicated in the coding below. It is also specified if the identification must be placed in the precise location indicated on the illustration [Precise] or if the placement is not specified in the guidelines [Floating].



Clothing

Competition clothing/
Warm-up suits

One identification of the manufacturer per clothing item will be permitted, to a maximum size of 30cm². One identification of the manufacturer will be permitted on Zippers and Buttons and should appear in the same colour as the concerned item (i.e. tone on tone), as long as such identifications are deemed not conspicuous by the IPC.

Unless otherwise approved by World Curling, a light-coloured uniform will be predominantly white or yellow in colour. There must be a minimum of 70% of white or yellow on both the front and back of the uniform. Dark-coloured uniforms can be any colour, excluding white and yellow, and must have 70% of the dark colour/colours on both front and back of the uniform.

Trousers, leggings and skirts must be the same colour for all team members but can be different brands. Teams can wear a mixture of trousers, leggings and skirts. Shorts are not allowed. The 70/30 rule doesn't apply. One or more athletes can use leg covers. The leg covers must be a continuation of the uniform design or neutral. If there is more than one, they must all be the same.

One additional product technology identification will be permitted per clothing item, to a maximum size of 10cm².

Base layer

White or the same colours as the light colour uniform when playing light coloured stones, black or the same colours as the dark colour uniform when playing the dark coloured stones. Visible base layers must be compliant with the 70% rule as mentioned above.

Collars and roll necks

If a roll neck or polo shirt is worn, no identifications of the manufacturer may appear on the collar or on the neck. Only one identifications of the manufacturer will be allowed; it may be situated on the chest, with a maximum size of 30cm².

Identifications on
IPC Team Apparel
Practical Guidelines
Milano Cortina 2026

Sport-by-Sport List

- WCF Wheelchair Curling

All General Principles apply unless expressly mentioned otherwise above (in particular in relation to size, frequency or location).



Sport Equipment

Brush/ Broom Each brush/broom may carry the identifications of the manufacturer as generally used on products sold through the retail trade at least six (6) months before to the Paralympic Winter Games as long as the manufacturer is deemed a Sports Brand. No markings are allowed on the part of the brush which touches the ice.

Each brush/broom may also carry the name of the country.
No team or athletes' names or nicknames are allowed on the brush/broom.

Delivery aid gripper/
Anti-slider May carry the identifications of the manufacturer as displayed on products sold through the retail consumer market at least six (6) months before the Paralympic Winter Games. They may also carry the name of the country, but no team or athletes' names or nicknames are allowed.

Warm up/
Competition gloves One identifications of the manufacturer per item will be permitted, to a maximum size of 15cm² or divided in two areas of a total of 15cm².

Mobility equipment

Wheelchair
Prosthetics One identification of the manufacturer per equipment item will be permitted, not larger than 10 per cent of the surface area of the item, to a maximum size of 60cm².

Wheelchair wheels One identification of the manufacturer per wheel will be permitted, not larger than 10 per cent of the surface area of the item, to a maximum size of 60cm².

Identifications on
IPC Team Apparel
Practical Guidelines
Milano Cortina 2026

Sport-by-Sport List

- WCF Wheelchair Curling

All General Principles apply unless expressly mentioned otherwise above (in particular in relation to size, frequency or location).



Accessories

Socks	One identification of the manufacturer per accessory item will be permitted, to a maximum size of 10cm ² .
Gloves	One identification of the manufacturer per accessory item will be permitted, with a maximum size of 8cm ² per glove.
Headgear	One identification of the manufacturer per Item, with a maximum size of 10cm ² or two identifications of the manufacturer per accessory item will be permitted, with a maximum size of 5cm ² each and placed above each ear. Team members can wear different styles of headgear. Caps must be worn with the peak forward. The headgear must be a continuation of the uniform. When a team has more than one item of any one type, e.g. two caps, two beanies, two headbands, they must be identical.
Eyewear	May carry the identifications of the manufacturer as displayed on products sold through the retail consumer market at least six (6) months before the Paralympic Winter Games, with the identifications permitted on the lenses so long as such identifications are tone-on-tone, engraved into the lens and are not deemed as conspicuous by the IPC.
Bag	One identifications of the manufacturer per item will be permitted, covering no more than 10% of the surface, to a maximum size of 60cm ² . The location of the Identification must be on the larger side of the bag. All team bags or backpacks positioned on the back of the wheelchairs in the Athlete Field of Play must be the same.

Shoes / Footwear

Curling shoes	All footwear items may carry the identifications of the manufacturer as displayed on products sold through the retail consumer market at least six (6) months before the Paralympic Winter Games.
---------------	---

Identifications on
IPC Team Apparel
Practical Guidelines
Milano Cortina 2026

Sport-by-Sport List

- WCF Wheelchair Curling

All General Principles apply unless expressly mentioned otherwise above (in particular in relation to size, frequency or location).



IF specific technical requirements

The following IF technical requirements apply in relation to the General Guidelines:

Section 8. Third party Identifications (athlete names)

On each competition jacket/sweater/playing shirt, the surname of the athlete appears across the upper back of the garment.

When two players have the same surname, the first letter of their given name shall be added to the player's name on the garment. If the first letter is also the same either another initial should be added, or the full or abbreviated given names shown.

Wheelchair

They may also be displayed along with the player's surname on the back of the seat in the same dimensions as for the uniforms in the following order:

Top: player's surname, middle: NPC emblem, bottom: NPC code.

Section 9. Maximising national and Paralympic Identity

The NPC code or country name must be printed across the back above the waist (visible when sitting). The NPC emblem may be worn on the back between the NPC code or country name and the athlete's name.

Identifications on
IPC Team Apparel
Practical Guidelines
Milano Cortina 2026

Sport-by-Sport List

- WCF Wheelchair Curling

All General Principles apply unless expressly mentioned otherwise above (in particular in relation to size, frequency or location).



Section 11. Homologation marks

Not required.

Coaches' Clothing

Regulations regarding coaches' uniforms Coaches clothing must follow the regulations in relation to the National Identification and Personal Identification – except in addition to the surname the word “Coach” or “National Coach” can be used as an alternative.

Section 18. Submission process

Pre Competition

Equipment may be subject to checking by the Technical Officials during practice or competition.

All General Principles apply unless expressly mentioned otherwise above (in particular in relation to size, frequency, location or Sports Brand requirements).

Identifications on
IPC Team Apparel
Practical Guidelines
Milano Cortina 2026

Sport-by-Sport List

- WCF Wheelchair Curling

All General Principles apply unless expressly mentioned otherwise above (in particular in relation to size, frequency or location).

22 GRAPHICAL ILLUSTRATIONS

Introduction

This section provides visual illustrations regarding the placement and size of the identification of the manufacturer on items of clothing and accessories that are common across all sports.

Please refer to the sport-by-sport list for any items not illustrated below and specifications regarding Sport Equipment.

Each type of identification mark is represented by a shape and colour, as indicated in the coding below. It is also specified if the identification must be placed in the precise location indicated on the illustration [Precise] or if the placement is not specified in the guidelines [Floating].

Please find below examples of product technology identifications (non-exhaustive):



Identifications on
IPC Team Apparel
Practical Guidelines
Milano Cortina 2026

Graphical illustrations

- Introduction



Clothing

This category includes articles of clothing worn by athletes, officials and other accredited personnel during all training sessions and competitions. Competition clothing is subject to additional IF regulations, specific to the respective sport. In all instances, where the clothing contains elastic material (e.g. LYCRA®), the identification of the manufacturer shall be measured as worn by the athlete (i.e., stretched). One identification of the manufacturer per clothing item will be permitted, with a maximum size of 30cm². No identification of the manufacturer may appear on or near the collar or on the neck.

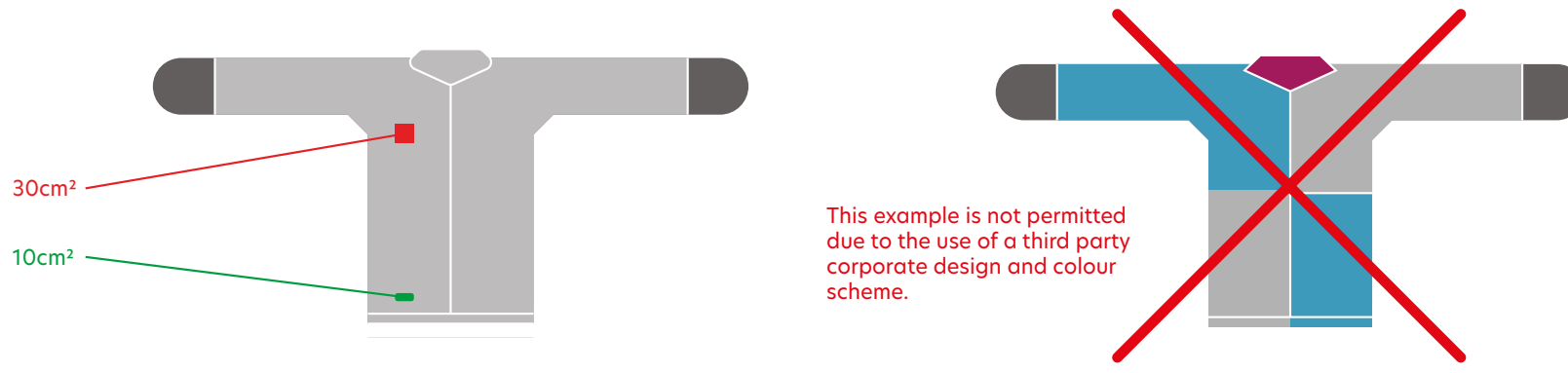

One-piece body suits

Where one-piece body suits are used in competition, one identification of the manufacturer and one product technology identification shall be permitted above the waist and below the waist, in accordance with the maximum size noted above, however these identifications shall not be placed immediately adjacent to each other.

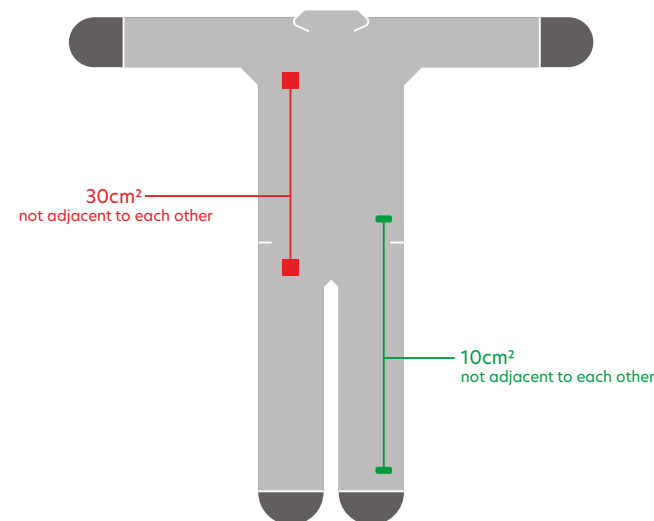

Identifications on
IPC Team Apparel
Practical Guidelines
Milano Cortina 2026

Graphical illustrations

- Clothing





Accessories

This category includes the articles of an accessory nature, worn or used by athletes and other participants within accredited Paralympic Games venues and sites. All accessories must actually be worn or used by the athlete, official or accredited personnel and must not be used for advertising purposes. Detailed specifications of accessory items for each sport are contained in the sport-by-sport list.

Socks

One manufacturer identification per item, with a maximum size of 10cm² or two marks of 5 cm² each.

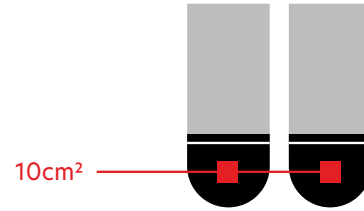

Headgear

One identification of the manufacturer will be permitted per item, with a maximum size of 10cm² or two identifications of the manufacturer per accessory item will be permitted, to a maximum size of 5cm² each, placed above each ear.

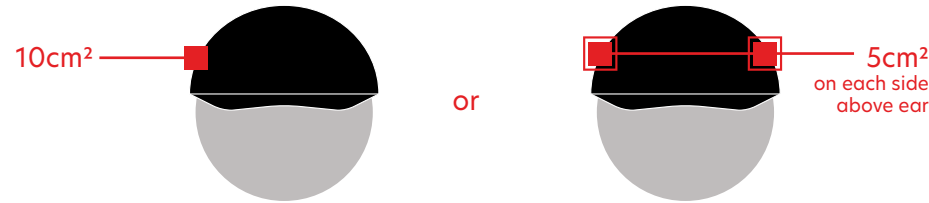

Eyewear

May carry the identification of the manufacturer as generally used on products sold through the retail trade during the period of six (6) months or more prior to the Games, with the identifications permitted on the lenses so long as such identifications are tone-on-tone, engraved into the lens, and is not deemed as conspicuous by the IPC.

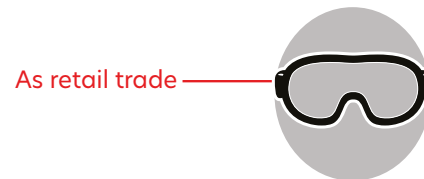

Identifications on
IPC Team Apparel
Practical Guidelines
Milano Cortina 2026

Graphical illustrations

- Accessories





Armbands

One identification of the manufacturer will be permitted per item, with a maximum size of 6cm².

Gloves

One identification of the manufacturer will be permitted per item, with a maximum size of 8cm².

Bags

One identification of the manufacturer will be permitted per item, not greater than 10% of the surface area of the item, to a maximum size of 60cm².

Non-branded items

Certain items may not feature any identification of the manufacturer: headphones, water bottles, umbrellas, towels, bandages, contact lenses, earplugs, mouth guards, nose clips, face masks, face shields and kinesiology tape (non-exhaustive list).

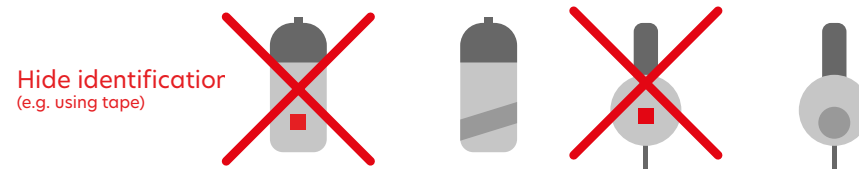
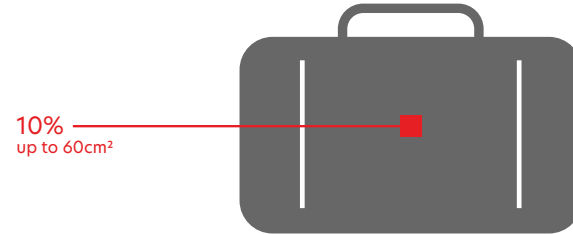

Identifications on
IPC Team Apparel
Practical Guidelines
Milano Cortina 2026

Graphical illustrations

- Accessories





20 SUMMARY

All parties involved in the design, production and use of items are advised to study the contents of these guidelines carefully. The IPC, IFs and LOCOG will work diligently prior to, and during, the Paralympic Winter Games to implement and enforce these regulations and are available to provide clarification as needed.

The Paralympic Family must work together to raise awareness and recognition for the Paralympic Movement, wherever possible. The Paralympians are the most recognizable ambassadors of the Paralympic Movement, and their pictures are carried all around the world. For this reason, it is important that we do not miss this opportunity to increase the awareness of our movement through the athletes, while protecting equity among the various stakeholders.

Each NPC shall be responsible for ensuring that all items worn or used by the members of its delegation comply with the guidelines. To maintain equity, any identification infringing upon these guidelines shall be removed or covered in accordance with the instructions given by the IPC, LOCOG or IFs.

To reiterate, any breach of the guidelines may lead to disqualification of or sanctions imposed on the athlete, NPC team official or the NPC, in accordance with the decision of the IPC Governing Board, or in accordance with the technical rules of the respective sport.

21 ACKNOWLEDGEMENT

Some of the contents of this document have been prepared using information contained in International Olympic Committee (IOC) publications, where applicable and with the permission of the IOC. We thank the IOC for their assistance and co-operation in sharing material and illustrations developed for the Olympic Winter Games.

© International Paralympic Committee March 2025

Identifications on
IPC Team Apparel
Practical Guidelines
Milano Cortina 2026

- **Summary**
- **Acknowledgements**



International Paralympic Committee
Dahlmanstrasse 2
53113 Bonn, Germany

Tel. +49 228 2097-200
Fax +49 228 2097-209
info@paralympic.org
www.paralympic.org